

Four human beings--changed by space-born cosmic rays into something more than merely human.

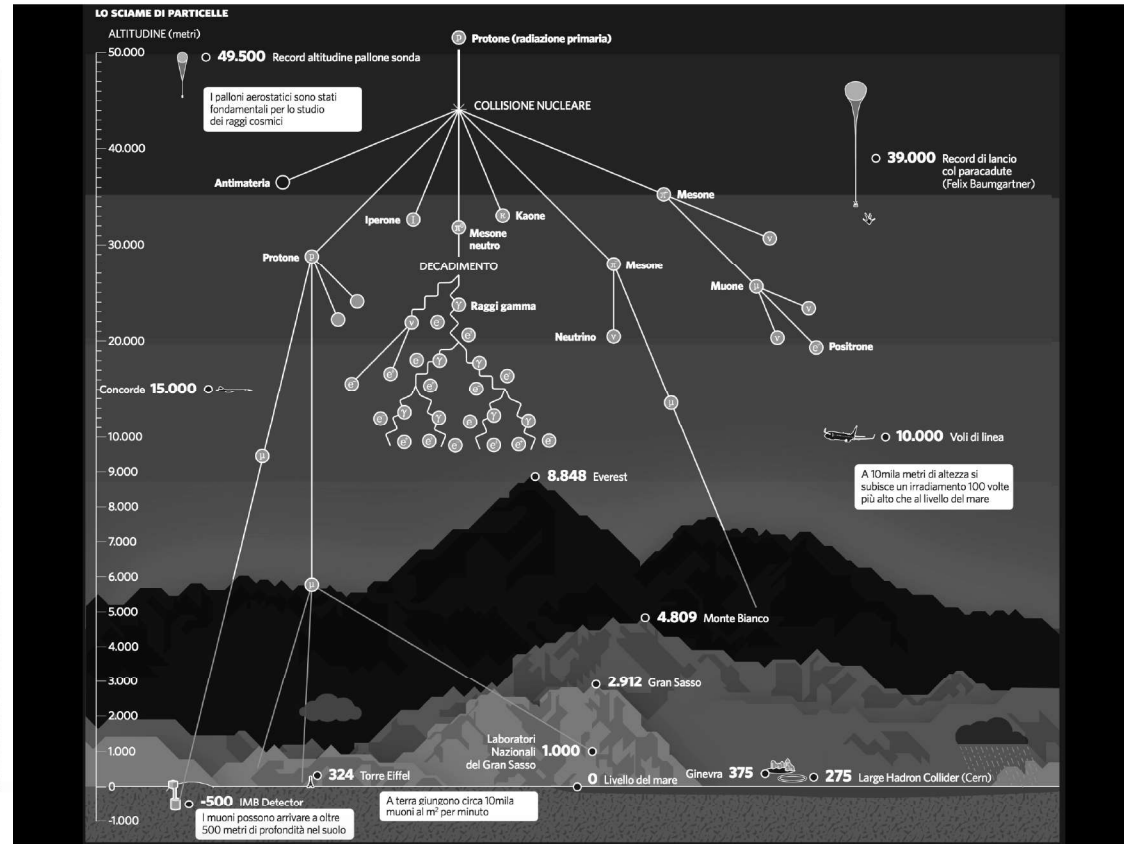

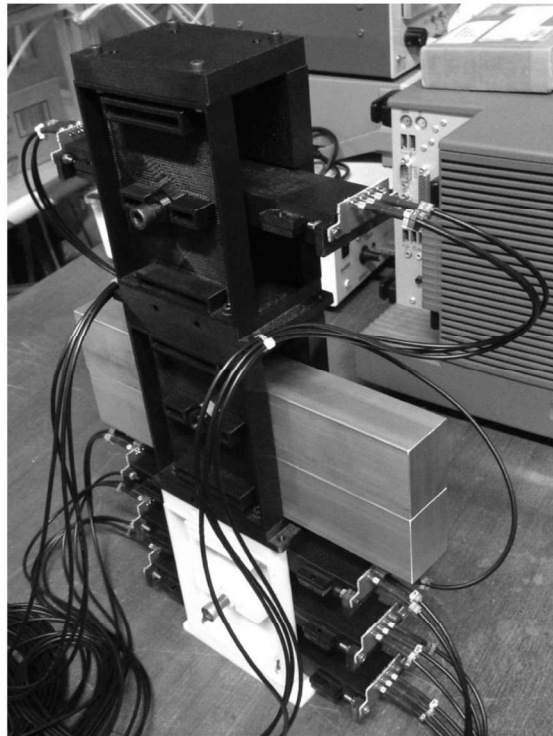

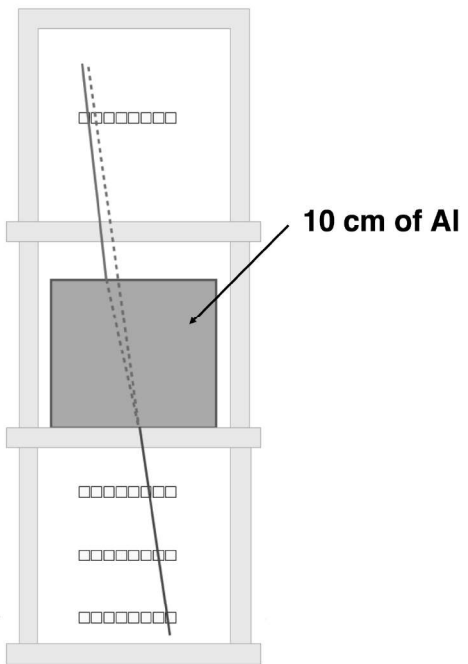
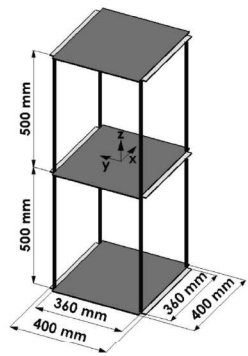

independent detectors

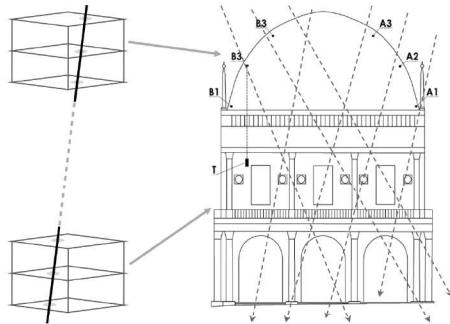

### Proposed detector

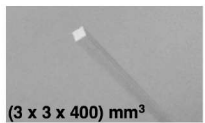
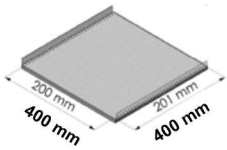

(3 x 3 x 400) mm<sup>3</sup>

- double layers of scintillating (3 x 3) mm<sup>2</sup> fibers
- fibers coupled to SiPMs
  - cheap
  - low voltage operation
  - good spatial and time resolution

nature

LETTER

doi:10.1038/nature24647

Discovery of a big void in Khufu's Pyramid by observation of cosmic-ray muons

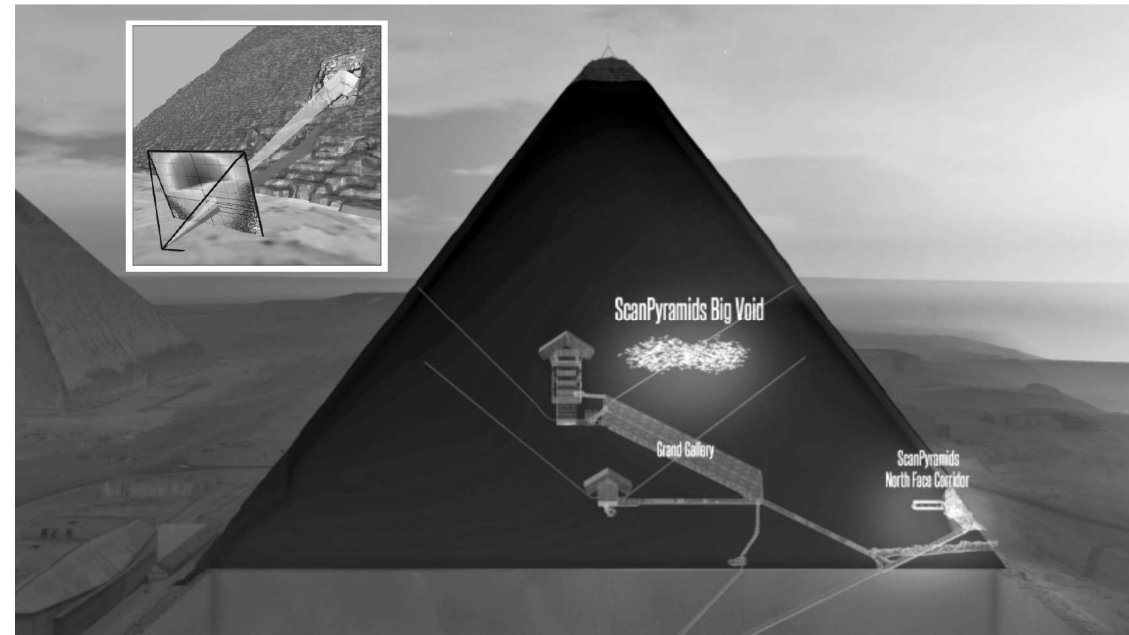



[http://www.fondazionemicheletti.eu/italiano/news/dettaglio\\_news.asp?id=329](http://www.fondazionemicheletti.eu/italiano/news/dettaglio_news.asp?id=329)

